

LEGO building tips and tricks:

Basic LEGO brick stacking:

The picture below shows how to stack two LEGO bricks on top of each other so that they snap together and are sturdy. This construction is not as sturdy as building with beams and pegs.

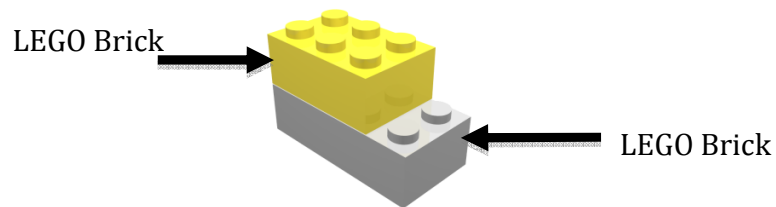

Using pegs to connect beams.

You can place a peg in one beam and snap on a second beam. However, these beams will be able to rotate unless you add a second peg

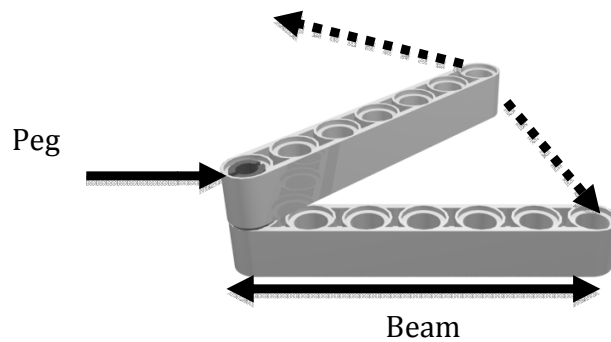

To prevent beams from rotating, use 2 pegs to secure beams in place. This technique should be used any time that you attach two beams together and do not want them to move.

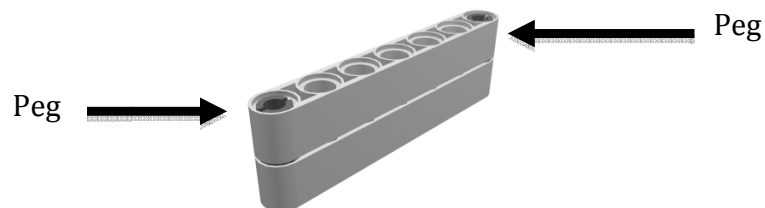

Connecting beams using axles and bushings:

You can also use axles to connect beams. Axles fit through the center of the beams and can be secured into place using bushings. This technique can also be used to attach wheels to a LEGO structure.

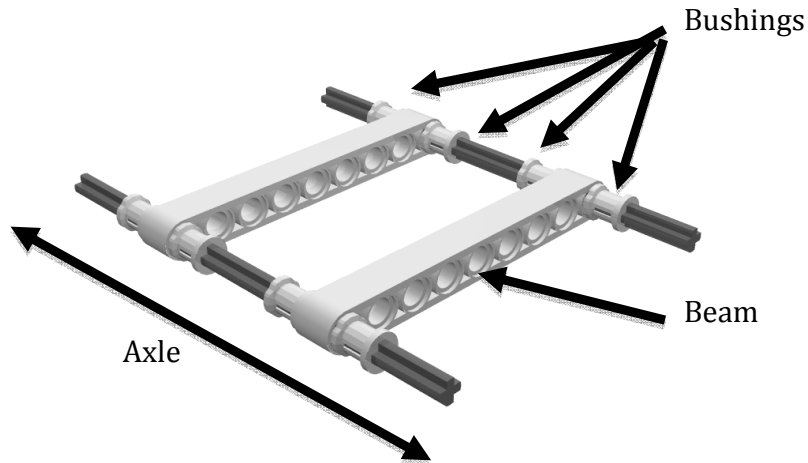

Constructing sturdy shapes:

To construct this simple square, you can use bent beams instead of straight beams. Bent beams are useful for changing an angle on a LEGO structure.

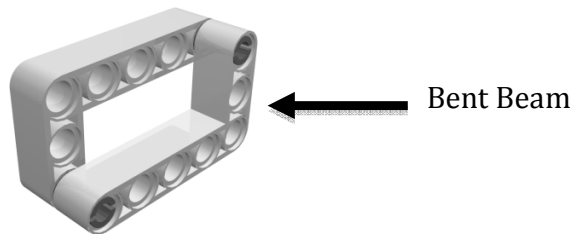

This triangle can be constructed using 3 straight beams, 2 pegs, and 1 extended peg. The extended peg is necessary for this construction because of the space between the beams. There are many other ways to construct a triangle out of beams:

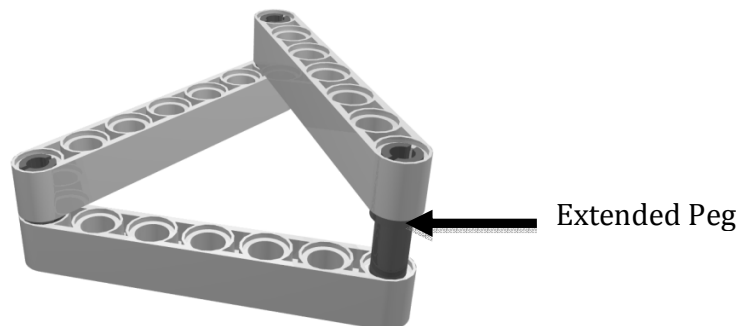

Attaching a wheel to a motor so that the wheel turns:

The orange part of the motor is the part of the motor that can be programmed to turn. Therefore, the wheel should be attached to the orange piece using an axle. This will ensure that your wheel turn when the motor is running.

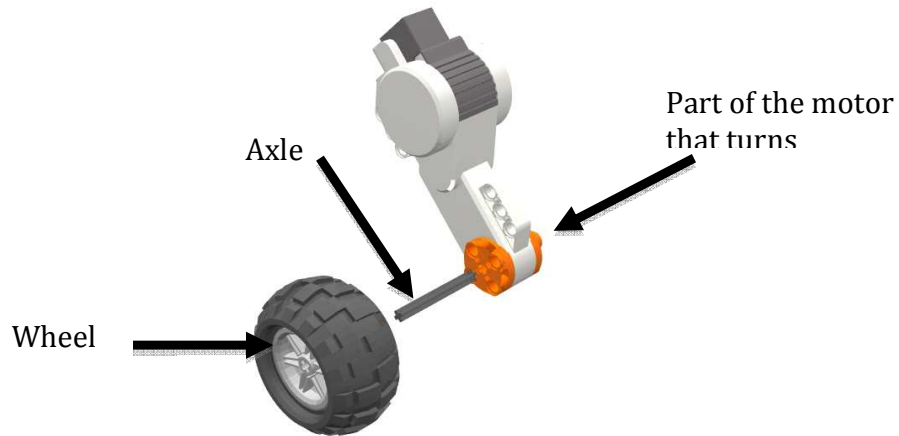

Attaching motors to your NXT:

There are several ways to attach the motors to the NXT. The pictures below give a few ideas of how you may want to orient and attach the motors to the NXT brick.

Angled motor assembly:

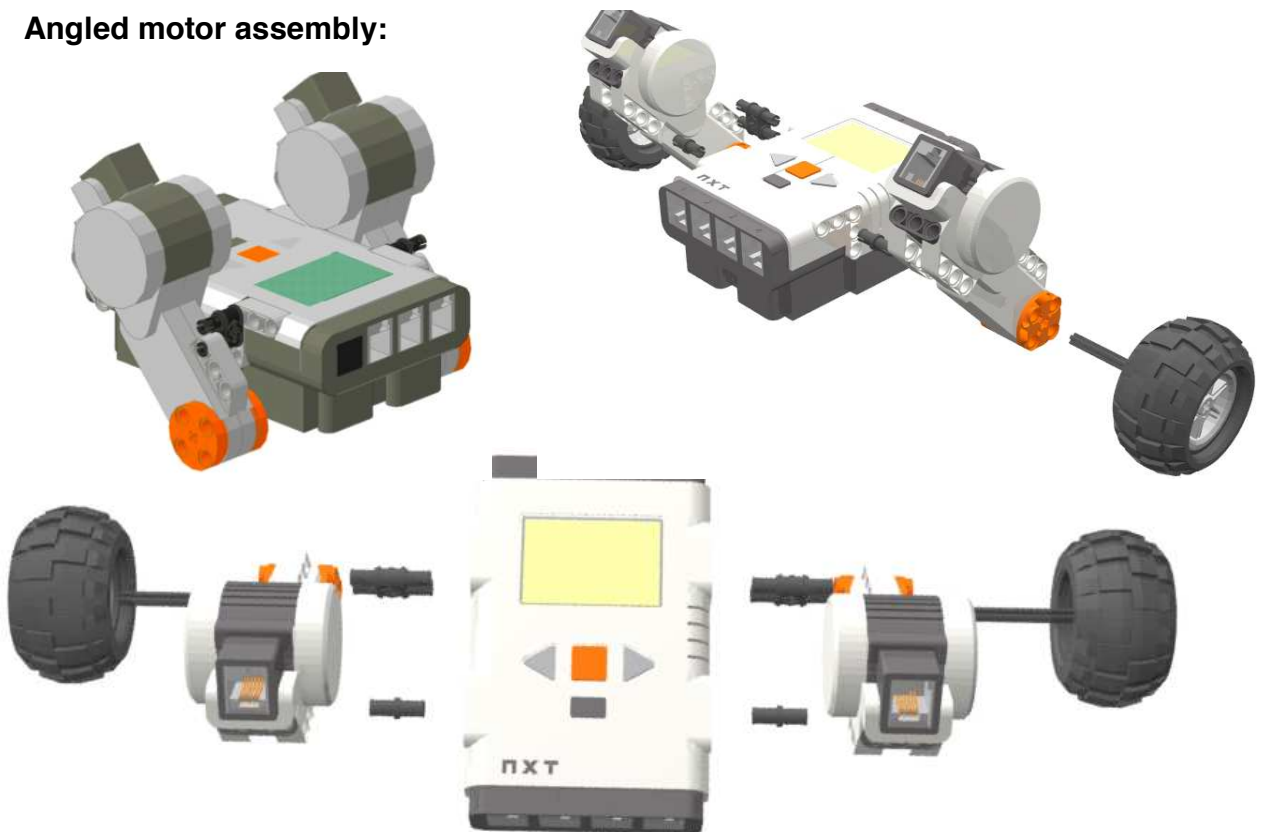

LEGO Building Tips and Tricks

Other Examples:

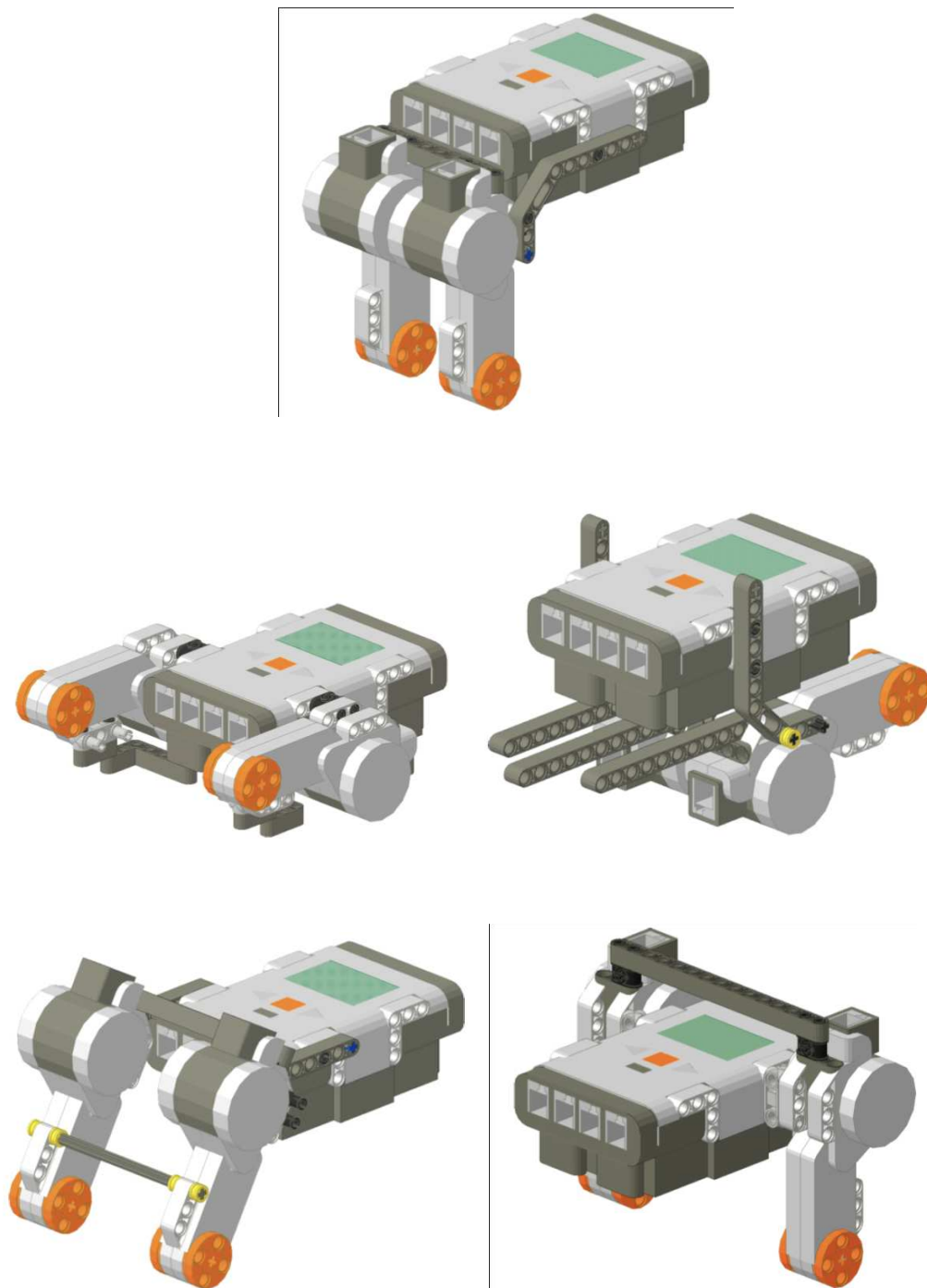

Ideas for Attaching a Front Support



Sample Building Projects:

Square:



LEGO Building Tips and Tricks

Box:

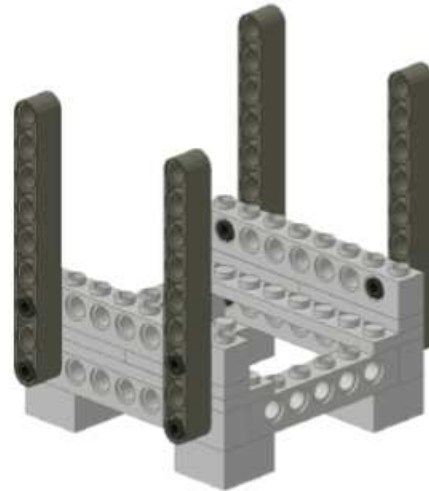
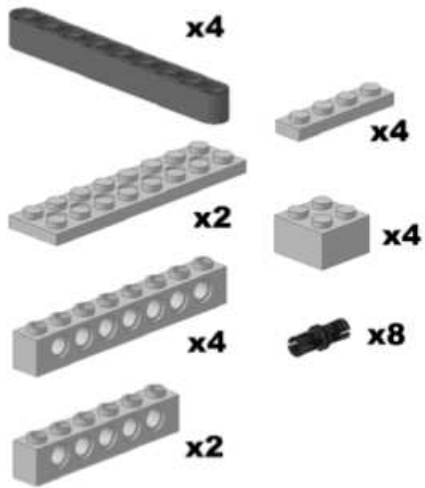

Arch:

